

Center for Wireless and Microwave Information Systems

Center for Wireless and Microwave Information Systems

<http://wami.eng.usf.edu/>

Department of Electrical Engineering
University of South Florida

Annual Report 2019/2020

Members: Dr. Huseyin Arslan, Dr. Lawrence Dunleavy (Co-Director), Dr. Gokhan Mumcu, Dr. Ashwin Parthasarathy, Dr. Stephen Sadow, Dr. Ismail Uysal, Dr. Jing Wang (Co-Director)

Contents:

- **Center Updates**
- **Student Recognition**
- **Research Highlights**
- **Professional Activities**
- **Selected Curriculum Activities**
- **Center Publications**

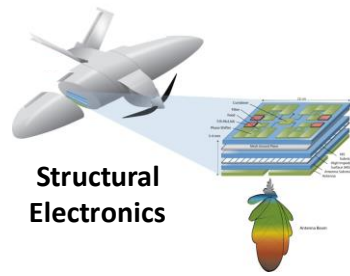
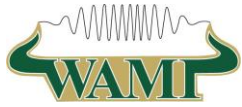

Structural Electronics

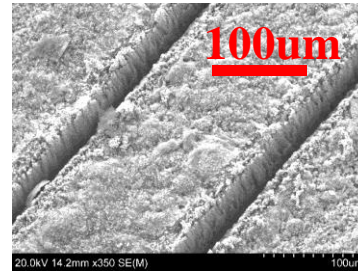

Laser Enhanced Additive Manufacturing

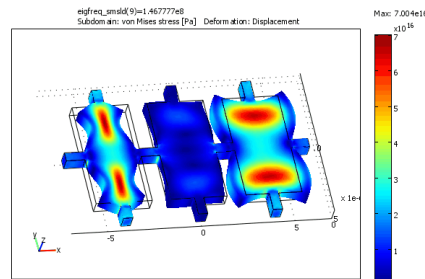

MEMS Filters

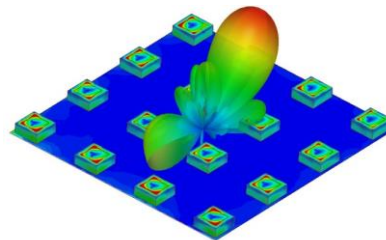

Mm-Wave Antenna Arrays

Summary

Now in its 23rd and 24th year, the Center for Wireless and Microwave Information Systems (WAMI Center) conducts research across a broad range of technical areas that include device modeling and characterization, micro electromechanical systems (MEMS), advanced functional materials and nanoscale devices, active antennas, microwave and mm-wave front-end transceivers, cognitive or software-defined radios, next generation wireless architectures and wireless sensor telemetry. Research projects focus on basic scientific development as well as applications such as biomedical sensing, communications, RF additive manufacturing and mm-wave packaging. Active collaborations have been pursued with many federal agencies and national research labs, numerous industry and university partners as well as other research centers at the University of South Florida.

In 2019/2020 the Center supported 35 MS and PhD students, one research faculty, and more than ten undergraduate students. Center faculty submitted over 30 research proposals in the past two years, among which more than 12 proposals have been funded. The WAMI faculty had more than 50 publications in journals, conferences and book chapters, 4 patents and gave more than ten invited talks. The Center students and faculty received 7 awards and distinctions including best paper/poster presentation awards and recognition for professional achievement. Since 2012, the productivity of the center includes:

- Paper published: 550
- Patents granted: 85
- Invited talks: 95

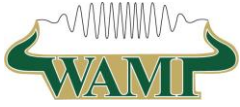



It is noteworthy that The USF WAMI Center is part of a rising star university! USF is rapidly rising on the list of Best US Public Universities, now No. 46, according to U.S. News and World Report's 2021 Best Colleges rankings. Over the past 10 years, USF has risen 78 spots among all universities, from No. 181 to No. 103, and raising 54 spots among public universities from No. 100 to No. 46 (No. 103 among all universities) to become America's fast-rising university. <https://www.usf.edu/news/2020/usf-is-americas-fastest-rising-university-according-to-us-news-world-report.aspx> .

Some Newsworthy Notes

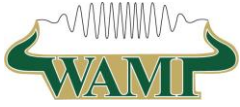
- The Center for Wireless and Microwave Information Systems (WAMI Center) started at the University of South Florida (USF) in 1997. For over 24 years, the WAMI Center has pursued excellence in research and education across many areas of wireless engineering, with a dual focus on advanced hardware technologies and wireless communications systems. The fields of application are diverse and include collaborators in marine science, pharmacy and medicine, transportation, materials science, physics, computer science, mechanical engineering, as well as chemical and biomedical engineering. Among its notable achievements, the Center has:
 - Produced over 550 refereed publications and 85 U.S. patents in the past 15 years (since 2008 report); more importantly, several patents have been licensed by major companies in the telecommunications field
 - Supported approximately 40 Ph.D. and M.S. students per year on a continuing basis; many of these graduates are employed at leading wireless companies and defense contractors
 - Created two internationally-recognized instructional laboratories with grant supports from the National Science Foundation (NSF)
 - Established the IEEE Wireless and Microwave Technology Conference (WAMICON) since 1999, an international event hosted in Florida each year that averages ~150 attendees and more than 25 industry exhibitors (<https://www.ieeewamicon.org/history>)
 - Generated >\$30M in research expenditures in the past 15 years (since 2008 report period)
 - Spun-out Modelithics Inc., the world's leading provider of microwave CAD models and Modelithics just reached the milestone of 20 Years in establishment on March 1st, 2021 <https://www.tampabaynewswire.com/2021/03/02/modelithics-reaches-milestone-of-20-years-in-establishment-96017>
 - Helped to secure a \$250K donation from Mini-Circuits to establish the Design for X Laboratory for the USF College of Engineering, which is now widely utilized by students across all departments within the USF College of Engineering
 - Secured the largest in-kind donation in the history of the University of South Florida thanks to WAMI center's over 25-year partnership with Keysight Technologies, Inc., with a Lab Naming Ceremony on January 22, 2016. The donation of Advanced Design System (or ADS software) is the largest in-kind donation ever in the history of the University. In honor of the donation, the instructional lab of Center for Wireless and Microwave Information Systems (WAMI Center) is being renamed the Keysight Technologies Wireless Laboratory <https://www.usf.edu/engineering/documents/010192016-keysight-dedication.pdf>

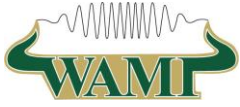

- The **2020 Rudolf E. Henning Distinguished Mentoring Award** was presented to Dr. Wayne Shiroma at WAMICON 2020/2021. Wayne A. Shiroma (Senior Member, IEEE) received the B.S. degree from the University of Hawai'i (UH) at Mānoa, Honolulu, HI, USA, in 1986, the M.Eng. degree from Cornell University, Ithaca, NY, USA, in 1987, and the Ph.D. degree from the University of Colorado at Boulder, Boulder, CO, USA, in 1996, all in electrical engineering. In 1996, he joined UH Mānoa, where he is currently a Professor and the Department Chair of Electrical Engineering. He was also a member of the Technical Staff at Hughes Space and Communications, El Segundo, CA, USA. He has authored over 130 publications in the areas of microwave circuits and antennas, nanosatellites, and engineering education. Dr. Shiroma served three terms on the IEEE Microwave Theory and Techniques Society (MTT-S) Administrative Committee, from 2002 to 2010, was the General Chair of the 2007 and 2017 IEEE MTT-S International Microwave Symposia, and received the IEEE MTT-S Distinguished Service Award in 2019. He was a recipient of the 2003 UH Regents' Medal for Excellence in Teaching, the ten-campus UH System's most prestigious teaching award. Since 2001, IEEE-HKN, the international honor society for IEEE, recognized four of his graduating seniors as the most outstanding electrical engineering students in the U.S.

- The former WAMI Center Director and EE Department Chair Dr. Tom Weller has moved to Oregon State University in fall 2018. While this is a loss for USF and gain for Oregon State University, the USF WAMI Center remains strong and we have many exciting developments to share with our external advisory board (EAB) affiliates during our next semi-annual EAB meetings. On related news, starting the same semester, Dr. Larry Dunleavy has resumed full-time faculty responsibilities at USF in January 2019. He has been working closely with Dr. Jing Wang to serve as Co-Directors of the WAMI Center. Dr. Dunleavy has been focusing on continuous improvement of WAMI related curriculum and laboratory activities as well as revitalizing WAMI's external affiliates outreach activities, an example of which is helping orchestrate the highly successful student-led/student-focused USF WAMI Student Forum now in its third year. The WAMI Student Forum has a dual goal of exciting students about career possibilities in the wireless and microwave/millimeter-wave field and exciting our external affiliates about the quality and depth of USFs research and teaching, inviting them into a partnership aimed at student development and success.

- Dr. Jing Wang, the Co-Director of the WAMI Center, has been promoted to the Agere Systems Endowed Chair since August 7th, 2020, which is a highly prestigious endowed chair professor position at USF College of Engineering. The endowment fund provides extra operating resources to support research activities for the purpose of boosting the success of the Center for Wireless and Microwave Information Systems (WAMI). In 2021, Dr. Wang was elected as a senior member of the National Academy of Inventors (NAI) in recognition to his pioneering contributions to the frontiers of functional



Center for Wireless and Microwave Information Systems

materials, sensors and wireless technologies. He holds 11 U.S. patents and several provisional patents. After joining USF WAMI center in 2006, Dr. Wang has mentored and graduated 17 doctoral students, who have joined leading RF and semiconductor industries, national labs and universities. <https://www.usf.edu/research-innovation/news/2021/nai-sr-members.aspx>

- Dr. Gokhan Mumcu has been promoted to Full Professor rank, starting on August 2021. Since joining USF in 2009, Dr. Mumcu graduated 10 Ph.D. students, who have joined to leading RF and semiconductor industries. He is a winner of NSF's prestigious CAREER award. His students regularly wins conference paper competition awards and travel awards from IEEE International Antennas and Propagation Symposium, most recent ones are in 2019 and 2020, respectively.



- Electrical Engineering Department at University of South Florida (USF) aims to transform into a connected research-students-practice model that promotes faculty engagement in professional formation of students where students themselves are empowered to become active participants. A key component is “track focused advisory boards (TFABs)”, which is modeled after the success of WAMI Center. The activity is being carried out under “IUSE/PFE:RED: Breaking Boundaries: An Organized Revolution for the Professional Formation of Electrical Engineers”, a prestigious NSF award with \$2M budget, in which Dr. Mumcu is a Co-PI.
- We are also excited to report that the USF College of Engineering has accepted our proposal for opening two new tenured/tenure-track faculty positions on the following research topics that are perfectly aligned with WAMI Center’s strategic plan and long-term missions: 1) radio frequency integrated circuits (RFICs) and systems, analog and mixed-signal RFIC designs and/or RF interfaces in advanced silicon and related emerging technologies, specifically in the areas of CMOS and SiGe RFIC design with targeted applications in millimeter-wave and/or terahertz (THz) wireless communications; 2) next-generation wireless communication and/or radar systems, with a particular focus on the innovative hardware/software implementation and emerging technology in machine learning and artificial intelligence, quantum photonics for communications, sensing, and computing. The positions are expected to commence August 2022. After joining USF EE Department, these chosen faculty candidates are anticipated to become active members of the WAMI Center that has been recognized for its mission to offer integrated research and education programs excelling in wireless and microwave technology. <https://www.higheredjobs.com/faculty/details.cfm?JobCode=177622017>

- Thanks to a timely “USF Tech Fees” technology improvement grant, the USF WAMI faculty /student team was able to respond quickly to the need to provide remote laboratory learning experiences for students that could not complete laboratory assignments in the traditional on-campus in-lab fashion due to COVID restrictions these past few semesters. The grant allowed for setting up new laptops, camera equipment and an “MS Hub” (kind of like a rolling smart board/electronic white board) system. Related to this we created a complete set of alternative video lab experiences to be used when no students were allowed to come to campus (and as a backup resource for make-up labs etc.). Also we now have what we call the “Remote live lab partner”



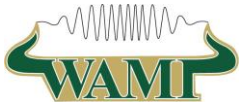

Center for Wireless and Microwave Information Systems

option to team up on-campus and off-campus students for lab completion. This allows for better “social distancing” if required policy or to alleviate related concerns

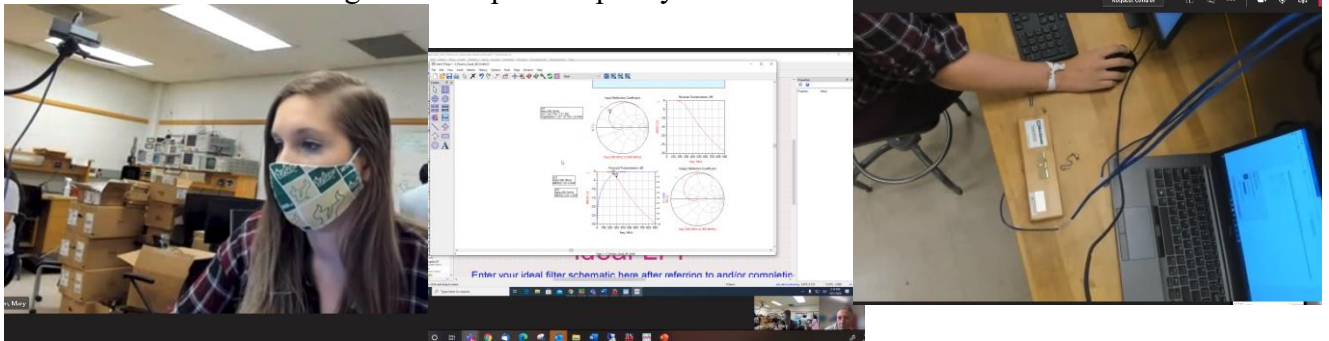

- Mini-Circuits continues to be a strong supporter of the WAMI Center and WAMI teaching laboratory by contributing microwave components. Mini-Circuits also began sponsoring some of its young engineers to enroll in the USF Graduate Certificate in Wireless Engineer as fully on-line students. Remote participation in hands-on laboratory assignments in USF’s Wireless Circuits and Systems Design Class (“WAMI Class”) and RF & MW Measurements class has been provide by creating satellite “cloned” versions of USF’s WAMI Teaching lab’s bench setups and supplementing with aforementioned remote live lab partner and video lab experience resources.



WAMI Satellite Test Bench at Mini-Circuits



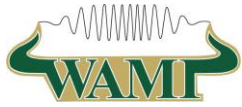

Center for Wireless and Microwave Information Systems



■ Since the inception of the USF WAMI concept, Keysight Technologies (formerly under the HP then Agilent Technologies' brands) has provided enabling and significant support of the ongoing equipment and software modernization of the WAMI teaching laboratory. As a result, some years ago, the USF WAMI Teaching Lab, itself been renamed as Keysight Technologies Wireless Laboratory. Most recently, in addition to significant annual software donation value,

Keysight offered a special educational discount on a total of 7 pairs of PXI Vector Network Analyzers and PXI Vector Signal Analyzers enabling testing up to 26.5GHz that allow the completion of the equipment updates for all the seven test benches in this lab. A timely feature of these new instruments is that they are fully controllable remotely, which facilitates our new “Remote Live Lab Partner” option to on-campus laboratory engagement.



■ Thanks in large part to efforts from our Department Chair to secure some laboratory improvement funding and lots of student labor assistance over the



summer– the Keysight Wireless (WAMI) Lab room itself has been completely updated with new flooring , freshly painted walls and brand new benches and cabinets giving our lab a fresh new look. Remember the saying “you never get a second chance for a first impression” and we want our undergrads to have a very positive first impression of WAMI related technology as they come into the lab for the very first time (vs. the 35+ year old bench look we had previously.)

■ Recent masters and Ph.D. graduates from the WAMI Center are now working for Raytheon, Akoustis Technologies, King Abdullah University of Science and Technology, MixComm, Qorvo, Modelithics, Draper Laboratory, Embry Riddle Aeronautical University, Georgia Tech Research Institute, II-VI Incorporated, ANSYS, Maxlinear, L3harris, Collins Aerospace, Intel, Samsung Research, Qualcomm, Cummins, Vectra AI (Silicon Valley startup), Sandia National Laboratories, and NTIA (The National Telecommunications and Information Administration).



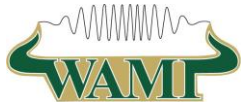



- When recommitting to an annual WAMI Center Technical Forum in fall 2019, a new WAMI External Advisory Board (EAB) membership structure has also been established. In recognition of the mutual benefits of an External Advisory Board (EAB) for the USF WAMI center and EAB members, membership benefits in three tiers are hereby defined along with the duties, organization, and obligations of the EAB. The objective of the EAB is to draw upon the wisdom and experience of selected leaders from industry and academia by providing advices on strategic plan while serving as liaison to industry. The EAB will assist the USF WAMI Center by providing expert opinion with a goal of improving WAMI Center’s national and international recognition through a process of continuous improvement.
 - Gold - Tier 2 (Gold) : with \$10K Annual Gift to WAMI Foundation
 - Silver - Tier 1 (Silver): with \$5K Annual Gift to WAMI Foundation
 - Bronze - Supporting: with \$3K< donation <\$5K Obtained through other support types – see “Other Opportunities”

Current or recent WAMI Gold and Silver EAB members include Gold members Mini-Circuits and Modelithics, and Silver Members Qorvo, Lockheed Martin, I3-Harris and Collins Aerospace. Bronze members currently include: Keysight Technologies, Xonar, II-VI, nScript, AFRL, Sciperio, ARL Sofwerx and Tecomsys. Renewal of memberships and new member recruitment is currently in progress!

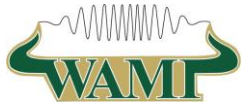
	Engagements & Benefits ¹	Tier 2	Tier 1	Supporting
1	Recognition in communications to students via email and other means ²	X	x	x
2	Sponsorship opportunities for branding at student group events and activities	X	x	
3	Opportunity to provide Capstone Design Class projects	X	x	x
4	Logo placement on WAMI Center Webpage	X	x	x
5	Logo placement at annual WAMI Student Forum ³	X	x	x
6	Invitation to annual WAMI Student Forum for presentation of internships and employment opportunities	X	x	
7	Invitation to annual meeting with student group leaders	X	x	
8	Invitation to periodic meetings with WAMI Center faculty (at least annual)- e.g. at WAMI EAB meetings.	X	x	x
9	(On request)One-on-one annual meetings with EE Department Chair and/or WAMI Center Faculty	X	x	
10	Consideration for membership in Electrical Engineering Department’s Advisory Board by invitation of the Department Chair	X		
11	Preferential to make presentations to the students, including technical presentations, career and professional advice.	X	x	
12	Faculty communication of internship and job opening information to undergraduate and graduate students.	X	x	



Student Recognition

- **Mohamed Mounir Abdin**, who is co-advised by Drs. Wang and Weller, has completed highly-prestigious one-year IEEE Microwave Theory and Techniques Society (MTT-S) Graduate Fellowship program in 2019 and he was awarded USF dissertation completion fellowship in 2019/2020. His research focuses mm-wave circuit design using additive manufacturing and 3D printing to facilitate the wide-spread adoption of 5G technologies by reducing the overall cost and complexity. One of his journal papers entitled “W-band MMIC Chip Assembly Using Laser Enhanced Direct Print Additive Manufacturing” has been accepted for publication in IEEE Transactions on Microwave Theory and Techniques in 2021. On route to completing his dissertation, he has demonstrated a 75-110 GHz (W-band) Tx/Rx transceiver pair by using additive manufacturing for packaging. His research focuses on the RF electronics, system-level design, and packaging. 
- **Poonam Lathiya**, a WAMI Ph.D. student advised by Dr. Jing Wang, gave a presentation entitled “Telemetry” and received People's Choice Award during the university-wide USF's 3 Minute Thesis Competition (3MT®) in November 2020 (<https://www.usf.edu/graduate-studies/research/three-minute-thesis-3mt/>). In addition, she has won the Best Poster Award for the International NanoFlorida Conference in November 2019. She has also been granted GMAG Travel Award for attending the American Physical Society (APS) March Meeting at Denver, CO, in March 2020 as well as a travel award to attend Institute of Electrical and Electronics Engineers (IEEE) Magnetics Society Summer School at Richmond, VA in 2019. Her research interests include synthesis and development of soft magnetic materials for RF and microwave devices. 
- **Vishvajitsinh Kosamiya**, a WAMI Ph.D. student advised by Dr. Jing Wang, received “Honorable Mention” for the USF Provost’s Award for Outstanding Teaching by a Graduate Teaching Assistant in 2021. Vishvajitsinh is going to act as the Chair for 2021 WAMI Student-Led Technological Forum, which will be held on campus on October 29, 2021. He will work closely with Jason Truong, who will act as the Co-Chair for the 2021 WAMI Student Tech Forum. Jason is an undergraduate student and a RF Engineering Intern at USF Institute of Applied Engineering. 
- **Kiran Shila**, a WAMI M.S. student advised by Dr. Gokhan Mumcu, received student paper competition honorable mention for APS 2020. His paper was rated in top ~30 out of 203 papers for the 2020 IEEE AP-S Symposium on Antennas and Propagation and CNC/USNC-URSI joint meeting (APS 2020) that was held in Montréal, Quebec, Canada on July 5-10, 2020. He also got the Best Student Poster Award during the 2019 WAMI Forum on October 25, 2019. Since fall 2020, Kiran Shila has been joined the doctoral degree program of the Electrical Engineering Department of the California Institute of Technology. 

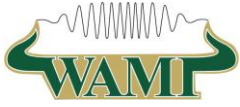

- **Enrique González**, a WAMI Ph.D. student advised by Dr. Gokhan Mumcu, received student paper competition honorable mention for APS 2019. His paper was rated in top ~30 out of 195 papers for the 2019 IEEE AP-S Symposium on Antennas and Propagation and CNC/USNC-URSI joint meeting (APS 2019) that was held in Atlanta, Georgia on July 7-12, 2019. His research focuses on mm-wave reconfigurable devices and beam-steering antenna arrays. In May 2020, Enrique joined Qorvo as a Senior Design Engineer after successfully defending his dissertation and graduating from USF.



- **Merve Kacar**, a WAMI Ph.D. student advised by Dr. Gokhan Mumcu, has been awarded a \$500 travel grant for attending the International Workshop on Antenna Technology (IWAT) held in Miami on March 3rd – 6th, 2019. She has also received the Best Student Poster Award during the 2020 WAMI Forum that was held as a virtual event on November 30, 2020. Since February 2021, Merve has joined MixComm Inc. as a Member of Technical Staff after successfully defending her dissertation and graduating from USF.



- A Capstone Design team (Ryan Carlomany, Ariel Duarte, Trevor Saunders, Dhairya Soni) that is advised by Dr. Gokhan Mumcu has been chosen one of the as top 6 semi-finalists in the Student Design Contest of the 2021 IEEE Antennas and Propagation Symposium that will be held in Singapore on December 4-10. IEEE APS is flagship conference of the IEEE Antennas and Propagation Society – it typically receives over 1,000 paper submissions and hosts over 1500 attendees.



Ariel Duarte



Trevor Saunders



Ryan Carlomany



Dhairya Soni



- **Arya Menon**, a WAMI Ph.D. student advised by Dr. Tom Weller, has been awarded the prestigious IEEE Microwave Theory and Techniques Society (MTT-S) Graduate Fellowship for 2019. She also received USF Provost's Award for Outstanding Teaching by a Graduate Teaching Assistant in the STEM category for the 2017-2018 academic year. In August 2018, She transferred from USF to Oregon State University by following Dr. Weller. Arya's research focuses on the development of a security scanner that combines radar and radiometric techniques for imaging. In May 2021, she joined Texas A&M University as a postdoc fellow after defending her dissertation.



- **Ismail Uluturk**, a WAMI Ph.D. student advised by Dr. Ismail Uysal has been awarded a \$1,500 international Travel Grant by the Office of Graduate Studies to present his work at the D4R – Data for Refugees – International Forum that was organized as a global big data competition. Researchers from around the world worked on using a large dataset of anonymized mobile phone data to provide a better insight into (and ultimately improve) the living conditions of more than 3.5 million refugees living in Turkey. The competition has received 100 submissions of which only 26 were accepted for presentation at the international forum which was held in Istanbul in January 2019.

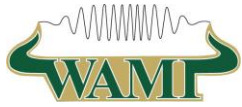



- **Omer Faruk Firat**, a WAMI Ph.D. student co-advised by Drs. Weller and Wang, has been awarded the best poster presentation award during the USF Graduate Student Research Symposium on March 4th, 2019, while receiving a conference travel grant of \$500. He conducted an internship training at Qorvo's mobile engineering department in Apopka, Florida in summer 2021. One of his papers entitled "Additively Manufactured, Low Loss 20 GHz DC Contact RF MEMS Switch Using Laterally Actuated, Fix-Free Beam" has been accepted by the 2021 International Microwave Symposium (IMS). 
- **Ruoke Liu**, currently a WAMI Ph.D. student advised by Dr. Jing Wang, has been awarded the Allan Gondeck Scholarship and Tom Tiedemann Scholarship in 2020 and 2019, respectively, thanks to her excellent overall GPA of 3.97 during her undergraduate study. She has made the Dean's list at USF College of Engineering in 2018 and 2019. She has also been elected as the Fall 2020 EE Department Outstanding Graduate, who is recognized during the College of Engineering Graduation Ceremony on December 4th, 2020. Her research focuses on RF additive manufacturing and packaging of mm-wave transceivers and active phased arrays. 
- It is worthwhile mentioning that the WAMI Center students has managed to sustain a six year winning streak for wining the prestigious IEEE Microwave Theory and Techniques Society (MTT-S) Graduate Fellowship between 2013 and 2018. This prestigious fellowships have been granted to 12 awardees globally each year during the International Microwave Symposium. Since 2014, WAMI Center students also won prestigious IEEE Antennas and Propagation Society (APS) Doctoral Fellowships that are granted globally up to 10 awardees each year. In addition, WAMI students have been awarded other prestigious fellowship, such as Phi Kappa Phi Dissertation Fellowship, which award 10 dissertation fellows in United States every year.
 - Arya Menon, awarded IEEE MTT-S Graduate Fellowship 2018
 - Mohamed Abdin, awarded IEEE MTT-S Graduate Fellowship 2017
 - Juan Castro, awarded Phi Kappa Phi Fellowship 2017
 - Juan Castro, awarded IEEE MTT-S Graduate Fellowship 2016
 - Abhishek Dey, awarded IEEE APS Doctoral Fellowship 2016
 - Maria Cordoba Erazo, awarded IEEE MTT-S Graduate Fellowship 2015
 - Maria Cordoba Erazo, awarded 2014 ARFTG Roger Pollard Memorial Student Fellowship in Microwave Measurement
 - Michael Grady, awarded IEEE MTT-S Graduate Fellowship 2014
 - Ahmad Gheethan, awarded IEEE APS Doctoral Fellowship 2014
 - Ibrahim Nassar, awarded IEEE MTT-S Graduate Fellowship 2013
 - Bryce Hotalen, awarded IEEE MTT-S Undergraduate/Pre-graduate Scholarship 2013
 - Evelyn Benabe, awarded Automatic Radio Frequency Techniques Group Student Fellowship Award – Silver
 - Evelyn Benabe, awarded IEEE MTT-S Graduate Fellowship 2010
 - David Cure, awarded NASA GSRP Fellowship 2010 and 2011.
 - Quenton Bonds, awarded NASA GSRP Fellowship 2009.

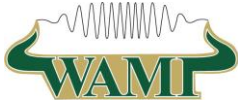

Professional Activities

- **Dr. Stephen Saddow and Dr. Jing Wang** along with three other USF faculty have been elected as Senior Members of the National Academy of Inventors (NAI) in February 2021.

For more than 25 years, Dr. Saddow has been a pioneer at the nexus of material science and biomedical engineering and is internationally recognized in the field of Silicon Carbide (SiC) Biomedical Technology. Dr. Saddow's research focuses on developing semi-conductor materials

for high-power device applications and biomedical applications. He currently leads a National Cancer Institute grant demonstrating that SiC can be used to treat deep-tissue cancer. He further discovered that porous SiC was an ideal scaffold for growing human bone cells, potentially advantageous for biomedical devices, and pioneered and developed implantable biosensors and other medical devices. He holds 13 patents.

Dr. Wang is a scholar and researcher pioneering advances on the frontiers of functional materials, sensors and wireless technologies. Dr. Wang was instrumental in advancing development of thin-film diamond on silicon acoustic resonator technology that can enable next-generation high-performance 5G wireless communications. A team led by Dr. Wang participated in the National Science Foundation's I-Corps program to develop technology that has the capacity to analyze the structural integrity of aging buildings and infrastructure with unusual shapes, such as bridges, to determine cracks and other potential weaknesses. He holds 11 U.S. patents, and several additional provisional patents.

<https://www.usf.edu/research-innovation/news/2021/nai-sr-members.aspx>



- On April 7, 2019, the WAMI Center Advisory Board Meeting was held in Cocoa Beach, Florida at the WAMICON 2019 hotel. During this meeting, attendees have supported the idea of holding the WAMI Center advisory board meeting on a semi-annual basis with a spring meeting during WAMICON and a fall meeting during an on-campus forum. After reporting all center activities, WAMI Center Membership options have been discussed.

- On October 25, 2019, the Fall 2019 WAMI Center Advisory Board Meeting was held on USF campus, which was scheduled at 9am-12pm right before the ½ Day on-campus WAMI Center Technical Forum in the afternoon. During this meeting, the Center Advisory Board was formally renamed as External Advisory Board (EAB), while the WAMI membership structure has been presented after gathering feedbacks from attendees related to how to strengthen the WAMI Center's partnership with industry and government organizations.



- On October 25, 2019, the 1st on-campus WAMI Center Student Technical Forum has been held, which is an annual ½ Day student focused and student led Technical Conference. The 2019 WAMI Forum held has attracted a total of 125 attendees including ~80 Students,

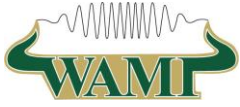

Center for Wireless and Microwave Information Systems

~20 faculty, and ~25 corporate/government visitors. Jonas Mendoza Sandoval (VP of the USF MTT-s student chapter) and Thomas DeCanio (USF IEEE Student Chapter President) have served as forum chair and forum co-chair, respectively. As a key highlight, the lunch panel with a central theme of “Career opportunities in wireless and microwave technology – might there be an exciting future here for you?” has become a big hit with student attendees. This lunch panel was followed by several technical talks and interactions between students and WAMI forum attendees during industrial exhibition hours and student research poster sessions. <https://www.linkedin.com/pulse/university-south-florida-wami-forum-panel-session-big-dunleavy/>



- On December 1st, 2020, the WAMI Student Forum 2020 was successfully held as an online virtual event, which was co-chaired by Jonas Mendoza (a WAMI Center Ph.D. student) and Noah Hamilton (USF IEEE Student Chapter President). As a virtual event, WAMI Student Forum 2020 has attracted 193 registrants. It is worthwhile mentioning that the online virtual meeting motif has been developed by Jonas Mendoza along with other forum committee members (WAMI students), which was modified and adopted by the IEEE WAMICON 2021 and it has gotten lots of compliments by attendees of both events.
-
- On April 28-29, 2021, the IEEE WAMICON 2021 was also held as a virtual conference. The WAMI Center has been heavily involved in the organization of the IEEE WAMICON 2021. Dr. Jing Wang and Dr. Larry Dunleavy have served as TPC Co-Chair and Invited Paper Chair, respectively. Also, colleagues from Mini-Circuits contributed to virtual platform development by working with Jonas Mendoza, the Chair of WAMI Student Forum 2019 and 2020.
-
- On May 14, 2021, the Spring 2021 WAMI Center EAB meeting has been held as a virtual event. Besides providing center updates and collecting suggestions from EAB affiliates, the preliminary date of 2021 WAMI Student Forum and Fall EAB meeting was discussed and subsequent sub-committee meetings have been proposed.
 - On July 16, 2021, WAMI EAB Curriculum & Senior Design Sub-Committee Meeting was held as a virtual event. During this meeting, the new process of formulating the Capstone Senior Design projects have been elaborate, which are heavily driven by industry. Industry defines the project and provides funding and/or access to needed resources. The status of the WAMI Teaching Lab renovation project has also been reported during this meeting. As of Fall 2021, we have 2 Capstone projects, which are based on research topics suggested by Mini-Circuits and Collins Aerospace. The Capstone team working with Mini-Circuits has been designing and implementing a VNA extension to higher/mm-wave frequencies.

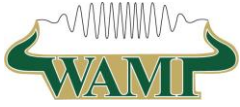

The Capstone team working with Collins Aerospace is conducting research on active dual band GPS antenna design and integration.

- On September 21, 2021, WAMI EAB Goals & Structure Sub-Committee Meeting was held as a virtual event. During this meeting, the WAMI membership structure and benefits have been reviewed and the preliminary plan for the 2021 WAMI Student Forum and 2021 Fall EAB meeting have been discussed. We have also provided a short report on the openings of new faculty positions with research topics aligned with WAMI Center’s missions.
- **Dr. Arslan** has offered tutorials in various IEEE conferences on 5G and Beyond Waveforms. He is also guest co-editor on the same topic for a special issue in PHY Communications Journal during 2018.
- **Dr. Uysal** served as a TPC Co-Chair for the Software and Applications track of IEEE RFID 2019 – IEEE’s flagship conference on RFID technology and applications – to be held in Phoenix, AZ, April 2-4th, 2019.
- **Dr. Mumcu** authored two book chapters:
 - 1) G. Mumcu, "Microfluidically reconfigurable antennas," in *Electromagnetic Waves, Developments in Antenna Analysis and Design: Volume 1: Institution of Engineering and Technology*, 2018, pp. 203-241
 - 2) G. Mumcu and T. Weller, "Small Antennas and Miniaturization Techniques," in *Antenna Engineering Handbook 5th Edition: McGraw Hill*, 2018, pp. 233-264.
- **Dr. Mumcu** had invited talks in 2018 URSI National Radio Science Meeting (NRSM) and 2018 IEEE International Microwave Symposium (IMS). His URSI NRSM talk was on X-band conformal antenna arrays using additive manufacturing techniques. His IEEE IMS talk was part of a workshop on tunable passive devices for multi-band systems. It focused on mm-wave beam-steering antennas and frequency tunable RF band pass filters using microfluidics based reconfiguration techniques.
- **Dr. Mumcu** served as Student Paper Competition Chair for the IEEE International Workshop on Antenna Technology (IWAT) that was held in Miami on March 3-6, 2019.
- **Dr. Dunleavy** has worked closely with Keysight Technologies and others to organize and deliver the highly successful “RF Boot Camp” at the IEEE MTT-S International Microwave Symposium. The RF Boot camp is a one day “crash course” held during IMS week each year, introducing newcomers to the field the basics of RF and microwave principles, measurements and simulations. This activity began with IMS2015, has had between 100 and 200 participants each year with very good reviews, and now offers CEU credits to boot. The next boot camp will be held in Boston in



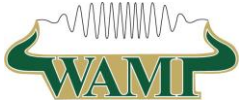

Center for Wireless and Microwave Information Systems

conjunction with the IEEE MTT-S IMS event there in June 2019. Former USF Department Dr. Tom Weller has also been involved as one of the featured tutorial speakers.

- **Dr. Wang** served as the Technical Program Committee (TPC) Co-Chair for WAMICON 2020/2021 by working closely with Steven Lardizabal from Raytheon, who acted as TPC chair. Amid Covid-19 pandemic, the WAMICON 2020/2021 as a consolidate conference was successfully held on April 28-20, 2021 as a virtual event that have addressed up-to-date multidisciplinary research needs and interdisciplinary aspects of wireless and RF technology. Its central theme is “Wireless Devices and Systems Making Mad Connections from Space to the 5G IoE”, while covering all aspects of related technologies, including antennas, passive and active circuits, communication theory, and system concepts. We would like to express our greatest gratitude to colleagues from Mini-Circuits and Jonas Mendoza Sandoval, who is a WAMI Center doctoral student, for creating virtual meeting platform and meeting motif for the WAMICON 2020/2021. Jonas has also served as chair for WAMI Center Technical Forum in 2019 and 2020, which is a student-led conference.
- **Dr. Wang** authored one book chapter entitled “Wireless Power Transfer using Near-field Communication” in *Wireless Power Transfer – Recent Development, Applications and New Perspectives*: IntechOpen, February, 2021.
- **Dr. Wang** has given a few invited talks at top conferences, online webinars and seminars for other research institutions including ECE Department seminar at University of Florida, Min H. Kao Department of Electrical Engineering and Computer Science at the University of Tennessee, Knoxville, an webinar on the topic of *Cutting Edge Digital Manufacturing: PART ONE*, International Conference on Nano and Materials Science, and so on.

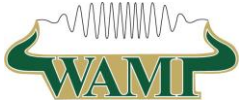

Center for Wireless and Microwave Information Systems

Research Highlights from Current & Recent Projects

- During the 2019/2020 academic years, USF WAMI Center has conducted research projects funded by prestigious grants/contracts from National Science Foundation (NSF), Air Force Research Laboratory (AFRL), United States Army Research Laboratory (ARL), United States Special Operations Command (USSOCOM), National Institutes of Health (NIH), Florida High Tech Corridor, National Aeronautics and Space Administration (NASA), USF Institute of Applied Engineering, L3Harris, Modelithics, II-VI, Tecomsys, nScript, Sciperio, XONAR, SOFWERX, as well as a USF Strategic Investment Pool award and a teaching technology advancement grant for creating quality remote lab experiences for the USF WAMI Lab class.
- Research and discovery in the RF/microwave/communications areas is the primary focus of the faculty and students in the WAMI Center. To enable this research, the Center maintains state of the art facilities for microwave/mm-wave characterization, and together with the USF Nanotechnology Research and Education Center (NREC) supports a wide range of micro- and nano-fabrication capabilities. A broad spectrum of measurement instrumentation is also available for research in the communications area. The Center supports comprehensive graduate curriculum that combines fundamental theory with many opportunities for hands-on, real-world engineering experience.

Title: Fully Packaged Wideband Phased Arrays Using Direct Digital Manufacturing

Collaborators: USF (Gokhan Mumcu and Jing Wang);
OSU (Thomas Weller);
Sciperio Inc. (Casey Perkowski and Kenneth Church);
AFRL (Bae-Ian Wu).

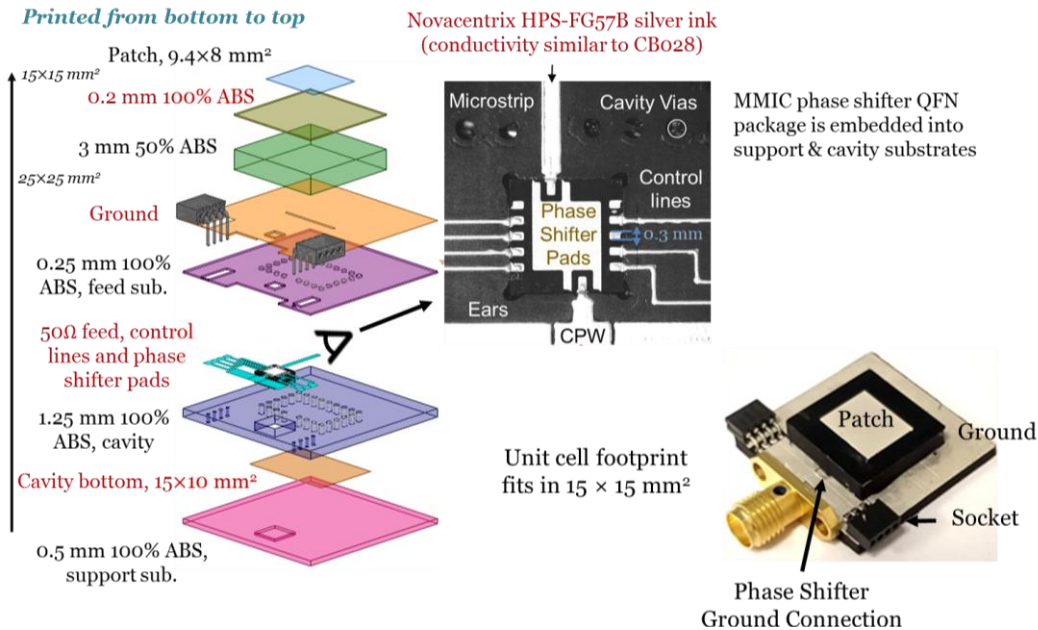
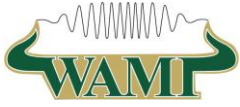

Fig.1. Fully packaged X-band antenna element with embedded cavity for platform installations and MMIC phase shifter for beam-steering capability within a phased array. It consists of nine material layers with customized dielectric constants and thicknesses. Demonstrates 24% impedance bandwidth, >80% radiation efficiency, >20 dB front-to-back radiation ratio. Phase shifting states (6 bit) are successfully verified.

Overview: Under multiple research awards from Air Force and Army SBIR programs, USF WAMI Center and Sciperio, Inc. are developing fully packaged, low-cost, low-profile and conformal wideband phased arrays. These phased arrays are enabled by strategically utilizing the unique capabilities of the Direct Digital Manufacturing (DDM) in the design and fabrication stages of the array. DDM is an additive manufacturing technique that allows implementing compact, cost-effective, lightweight multilayer RF devices exhibiting alternating dielectric and conductive layers with design flexibilities in making material choices, layer thicknesses, and material shapes. These flexibilities allow the additively manufactured RF device performance to meet or exceed the performance level of those implemented with the well-established traditional manufacturing approaches. Our on-going work at X-band successfully demonstrates phased array unit cells fully packaged with MMIC phase shifters and embedded cavities as shown in Fig. 1. The unit cells are characterized to operate with 24% impedance bandwidth and >80% radiation efficiency with > 20 dB front-to-back radiation ratio. The unit cell overall consists of nine material layers. Five of these are dielectric material layers with customized thicknesses and dielectric constant properties. Remaining four layers are conductive with minimum feature sizes down to 150 μm to integrate the commercial-of-the-shelf (COTS) MMIC QFN package within the unit cell volume with the required bias, control and RF in/out lines. It is important to note that USF and Sciperio, when necessary, utilize a picosecond laser capability within the DDM process to perform IC and antenna packaging in the die level with minimum feature sizes reaching down to 10 μm as seen in Fig. 2. The project has successfully moved into Phase II and unit cells are being now utilized towards realization of beam-steering subarrays with the inclusion of more material layers and necessary design modifications. Subarray details are currently not available for public release. The USF team funded by this SBIR Phase II contract has finished the design of a 4 x 4 phased array antenna and nScript has 3D printed the custom-designed phased array antenna on a curved surface as shown



Center for Wireless and Microwave Information Systems

in Fig. 2. The subcontractor on this project was the University of South Florida (WAMI Center), which was part of the project that developed the world's first fully 3D printed phased array antenna, and supported the design, simulation, and testing of the antennas for the current project. According to Dr. Bae-Ian Wu, Technical Advisor of the Multiband Multifunction Radio Frequency Sensing Branch, Sensors Directorate - AFRL, nScript's 3D manufacturing system and Sciperio's engineering expertise have enabled them to model complex, multi-layer RF electrical structures for printing on doubly curved surfaces, extend and debug modelling and simulation, address interconnects, and tie digital workflow and manufacturing. More information can be found through a press the release article by nScript. <https://www.everythingrf.com/News/details/12465-nscript-3d-prints-phased-array-antenna-on-a-curved-surface-for-the-us-air-force>

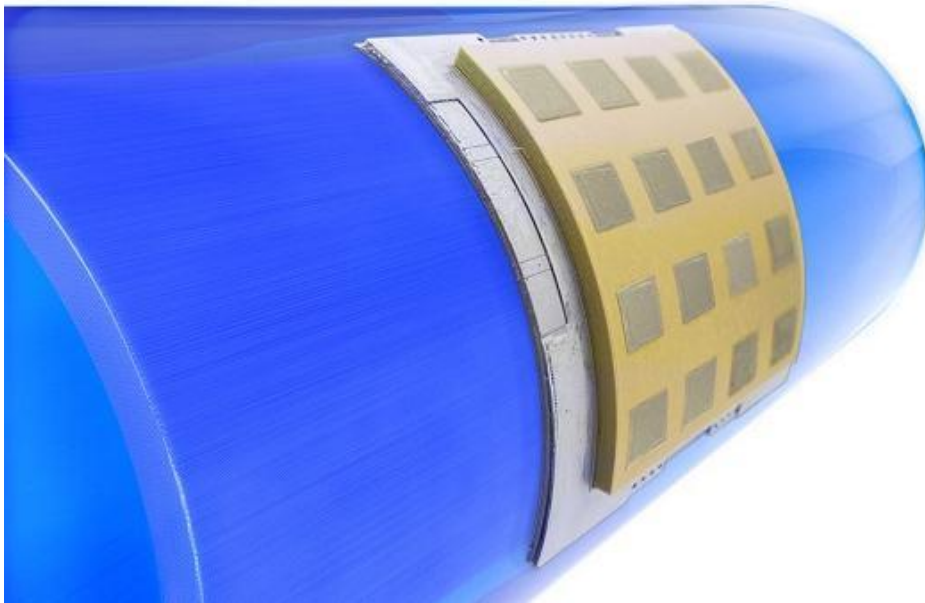

Fig. 2. Image of a 4 x 4 phased array antenna designed by WAMI Center researchers, which was 3D printed by nScript for a project funded by the Sensors Directorate of the U.S. Air Force Research Laboratory (AFRL). nScript's Factory in a Tool (FiT) 3D manufacturing system, integrates a high-precision motion platform, surface mapping, multi-camera machine vision, and multiple tool heads for material extrusion (aka FDM or FFF), microdispensing, aerosol jetting, milling and polishing, and picking and placing electronic components. Combining all these processes and capabilities into a single platform enables the manufacture of complex structural electronics at the press of a button.

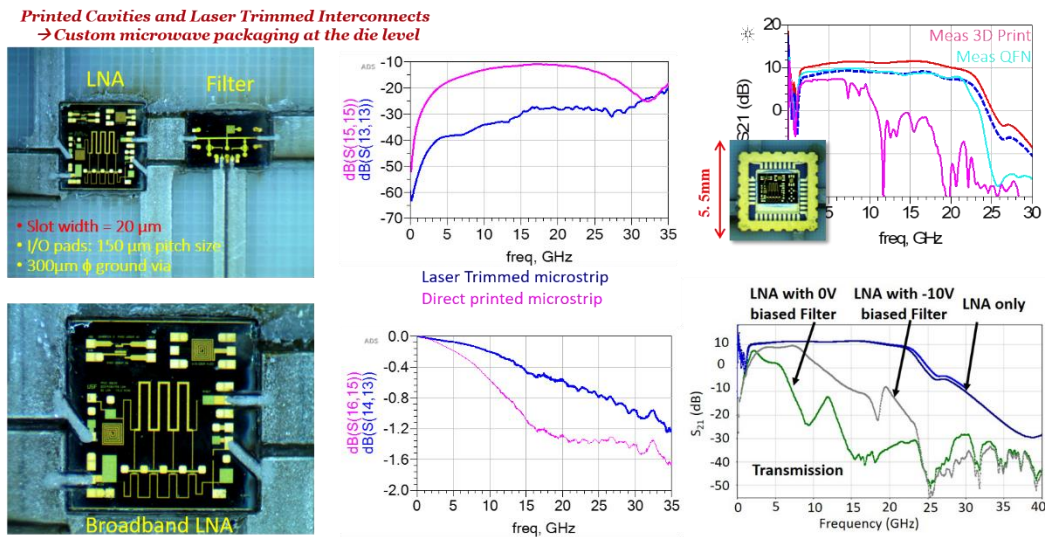

Fig. 3. Fully packaged multi-chip mm-wave front-end module demonstration through laser enhanced direct print additive manufacturing (LE-DPAM) has been successfully implemented and verified. This example includes one broadband distributed amplifier followed by a tunable filter that are laterally integrated via a LE-DPAM process.

Title: MMIC packaging and on-chip low-loss lateral interconnection by using RF additive manufacturing and laser machining

PIs: USF (Jing Wang);
 OSU (Thomas Weller).

As shown in Fig. 3, a new and versatile 3D printed on-chip MMIC integration approach using laser machining is demonstrated in this work for microwave and mm-wave systems. The integration process extends interconnects laterally from a MMIC chip to a 3D printed chip carrier. Pico-second laser machining techniques are studied and characterized to enhance the 3D printing geometry in terms of feature size and dimension accuracy down to sub-4 μm . Specifically, the width of microdispensed printed traces is accurately controlled within micrometer range and probe pads are formed by laser cutting to facilitate RF measurement. S-parameters of a distributed amplifier integrated into the package are simulated and measured from 2 to 30 GHz. The overall performance is significantly better than traditional wire-bonded QFN package. The attenuation of the microstrip line interconnects is only 0.2 dB/mm at 20 GHz and return loss with the package is less than 10 dB throughout the operating frequency band. The measured S-parameters of the QFN-packaged distributed amplifier (DA) are plotted in comparison with the 3D printed packaged DA. Due to strong parasitic effects of the wirebonds and the frequency limitation of the QFN package, the bandwidth of the DA is limited to 12 GHz showing a gain reduction of 2 dB when compared to the DA integrated in the 3D printed package. Fig. 4 summarizes the obtained attenuation results of the interconnection (i.e. 0.2dB/mm at 20 GHz) as compared to prior works. The LE-DPAM package outperforms previous printed interconnects in terms of insertion loss by at least 0.125 dB at 5 GHz and 1.2 dB at 20 GHz. Recently, we have extended this work by implementation of a W-band (75-100 GHz) MMIC chip assembly. More details can be found in a journal article entitled “W-band MMIC Chip Assembly Using Laser Enhanced Direct Print Additive Manufacturing” that was accepted for publication by IEEE Transactions on Microwave Theory and Techniques in 2021.

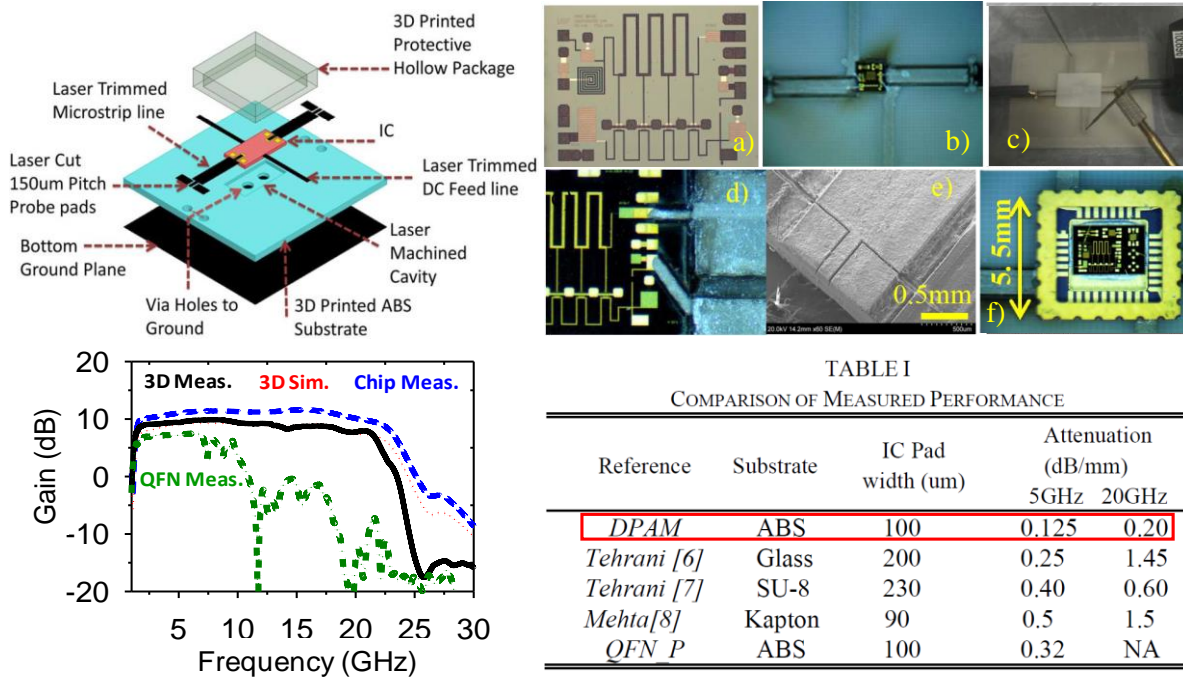

Fig. 4. First ever demonstration of MMIC packaging and on-chip low-loss lateral interconnection using additive manufacturing and laser machining, which has achieved best of its kind RF performance at mm-wave frequencies.

Title: Microfluidically Reconfigurable Millimeter Wave Switches and Beam-Steering Antenna Arrays

PI: Gokhan Mumcu

Overview: Microfluidics based reconfiguration techniques can be harnessed to design and construct RF devices with large frequency tuning ranges and low insertion losses while providing significantly higher power handling capabilities. Dr. Mumcu’s work on this research area dates back to 2013 with his initial work on liquid metal based frequency tunable RF band pass filters and antennas. Since then, his work has continued under three National Science Foundation (NSF) grants one of them being the prestigious CAREER award. A significant milestone of his research was the demonstration of devices that replaced liquid metals with metallized plates to perform at much higher frequencies without reliability issues of the liquid metals. Most recently, another milestone has been reached by actuating the metallized plates within the microfluidic channels with piezoelectric disks as shown in Fig. 5. This *internal actuation* mechanism removes the need for external microfluidic pumps while providing very low actuation time – initially characterized as ~1 ms for mm-wave SPST switches with possibilities to reduce further as research progresses. To the best of knowledge, these are the fastest microfluidically actuated RF devices reported to date with very high reliability. Such switches can handle continuous RF power levels up to 25 W with no addition of thick ground planes or heat sinks. Realization of multi-throw switches for efficient mm-wave beam-steering has recently been proposed as shown in Fig. 5 and recognized with an honorable mention from the highly competitive IEEE APS symposium student paper

competition (student author: Enrique González). Other application areas being pursued are mm-wave reconfigurable filters, phase shifters, and focal plane beam-steering arrays.

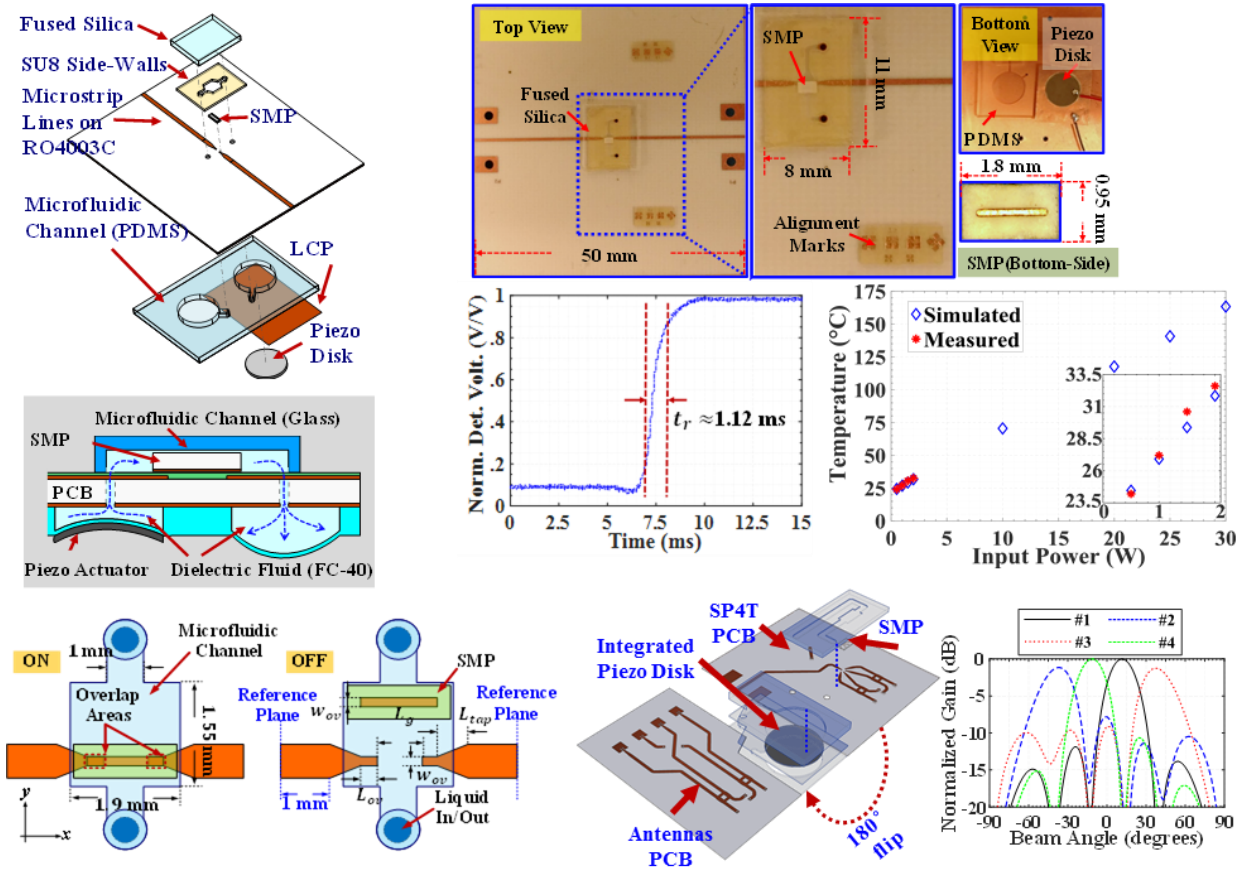

Fig. 5. Mm-wave (22 – 40 GHz) SPST switch microfluidically actuated with piezoelectric disk (12.7 mm diameter under the ground plane). Characterized to operate with: 0.42 dB insertion loss, 20 dB isolation, 12 mW power consumption (only during actuation), 25 W continuous RF power handling. The concept is being extended to multi-throw switches and beam-steering arrays.

Title: Lens Antenna Subarrays (LAS) for Low-Complexity, High Data Rate and High Energy Efficiency Mm-Wave Communications

Collaborators: USF (Gokhan Mumcu, Huseyin Arslan, and Jing Wang);
 OSU (Arun Natarajan, Bechir Hamdaou, and Thomas Weller);
 Keysight Technologies (Stacy Johnson)

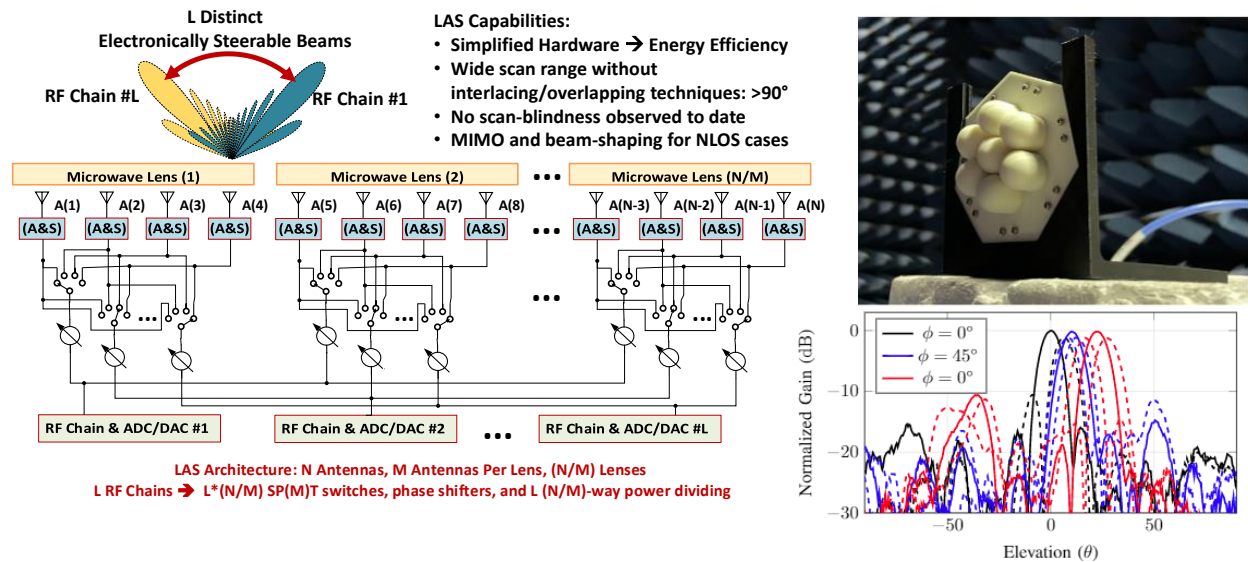
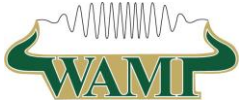

Fig. 6. (Left) Lens antenna subarray (LAS) architecture generalized for multiple RF chains to perform multi-stream MIMO, (Right) A 38 GHz LAS based antenna that is equivalent of a ~ 100 element traditional phased antenna array, performing with $\sim \pm 40^\circ$ scan range and lower than ~ -10 dB side lobe level.

Overview: Under NSF SpecEES program, USF is investigating a new subarray technology to realize low-cost and low-complexity phased antenna arrays. In contrast to the traditional subarray techniques that significantly sacrifice the beam steering range, USF’s technique relies on “lens antenna subarrays (LASs)” that maintain the beam steering capability within subarrays with the inclusion of an RF switch networks (see the architecture of Fig. 6). Consequently, the LAS based antennas can exhibit large beam steering ranges with much fewer number of phase shifters. A recent 38 GHz LAS based antenna design and experiment demonstrated that the technology can indeed perform as predicted from the concept and theory, replicating the beam steering performance of a ~ 100 element traditional phased antenna array by needing only a total of 7 phase shifters (i.e. 1 per lens). In recent publications, USF also demonstrated that LAS based antenna architectures maintain a high level of spectrum efficiency in mm-wave wireless communication networks, while reducing the total power consumption. This therefore results in significant gain in energy efficiency (i.e. data rate per Watt).



Center for Wireless and Microwave Information Systems

Selected Curriculum Activities

The instrumentation in the Wireless Circuits and Systems Design Laboratory had a major upgrade at the end of 2017 and during 2019, thanks to a very generous discount (90%) on \$700,000 in new vector network and spectrum/signal analyzers. All previous generations of network analyzers and spectrum analyzer such as ones shown in the image to the right have been repurposed at some legacy test benches. All 7 test benches in the lab are now equipped with 9 GHz or 26.5 GHz vector network analyzers and 26.5 GHz signal analyzers, both controlled through a PXI chassis. The teaching assistants managed to update all experiments and documents in time for the spring 2018 semester. A modulation/demodulation lab was newly introduced in the fall 2017 semester, as well.

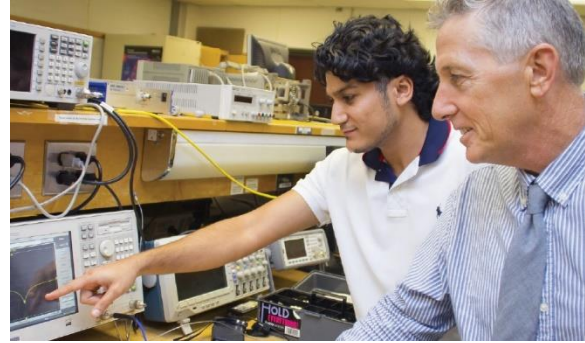

In summer 2020, Dr. Dunleavy has submitted a proposal and won an internal teaching technology advancement grant (\$33.2k) for creating quality remote lab experiences for delivering the WAMI Lab class. This grant enables WAMI lab to add state-of-the-art AV tools on each test bench, while adding a 50" Microsoft Surface Hub for in-lab lectures. In summer 2021, EE department chair also

provided additional funds to acquire 22 new test benches and 2 cabinets, while installing new floor and painting walls to complete the WAMI lab renovation project. The newly renovated and fully equipped Keysight Technologies Wireless Lab will support several EE Department courses and it will be ready for a lab tour by WAMI EAB affiliates during the fall 2021 EAB meeting.



Electrical Engineering Department at University of South Florida (USF) aims to transform into a connected research-students-practice model that promotes faculty engagement in professional formation of students where students themselves are empowered to become active participants. A key component is “track focused advisory boards (TFABs)”, which is modeled after the success of WAMI Center. The activity is being carried out under “IUSE/PFE:RED: Breaking Boundaries: An Organized Revolution for the Professional Formation of Electrical Engineers”, a prestigious NSF award with \$2M budget, in which Dr. Mumcu is a Co-PI. <https://govtribe.com/award/federal-grant-award/project-grant-2022299>

A Capstone Design team (Ryan Carlomany, Ariel Duarte, Trevor Saunders, Dhairya Soni) that is advised by Dr. Gokhan Mumcu has been chosen one of the as top 6 semi-finalists in the Student Design Contest of the 2021 IEEE Antennas and Propagation Symposium to be held in Singapore on December 4-10, 2021. IEEE APS is flagship conference of the IEEE Antennas and Propagation Society. It typically receives over 1,000 paper submissions and hosts over 1500 attendees.

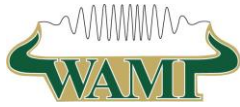

Publications

1. M. M. Abdin, W. J. D. Johnson, J. Wang and T. M. Weller, "W-band MMIC Chip Assembly Using Laser Enhanced Direct Print Additive Manufacturing," *forthcoming in IEEE Transactions on Microwave Theory and Techniques*, 2021.
2. O. F. Firat, J. Wang and T. M. Weller, "Additively Manufactured, Low Loss 20 GHz DC Contact RF MEMS Switch Using Laterally Actuated, Fix-Free Beam," *2021 IEEE MTT-S International Microwave Symposium (IMS)*, Atlanta, GA, June 19-24, 2021.
3. P. Lathiya and J. Wang, "Wireless Power Transfer using Near-field Communication," in *Wireless Power Transfer – Recent Development, Applications and New Perspectives*: IntechOpen, Feb. 2021.
4. X. Han, D. Lan and J. Wang, "ZnO-on-Diamond Resonators with Notched Thin-Film Piezoelectric Interdigital Transducer for Enhanced Signal-to-Noise Ratio and Feedthrough Suppression," *2020 IEEE 33rd International Conference on Micro Electro Mechanical Systems (MEMS)*, 2020, pp. 1289-1291.
5. D. C. Lugo, J. Wang and T. M. Weller, "Analytical and Experimental Study of Multilayer Dielectric Rod Waveguides," in *IEEE Transactions on Microwave Theory and Techniques*, vol. 69, no. 4, pp. 2088-2097, April 2021.
6. A. Zaman, A. Alsolami, I. F. Rivera and J. Wang, "Thin-Piezo on Single-Crystal Silicon Reactive Etched RF MEMS Resonators," *IEEE Access*, vol. 8, pp. 139266-139273, 2020.
7. J. Cotter, J. Wang and R. Guldiken, "Intrinsically patterned electrical systems: physical requirements and experimental demonstration," *Microsystem Technologies* (2020), July 2020.
8. J. Han, P. Yang, J.-Z. Wu, T. Wang and J. Wang, "Directional transmission of ultra-high frequency acoustic signals based on metamaterial structure," *AIP Advances* 9, 125209 (2019).
9. T. Wang, R. Green, R. Guldiken, J. Wang, S. Mohapatra, S. Mohapatra, "Finite Element Analysis for Surface Acoustic Wave Device Characteristic Properties and Sensitivity," *Sensors (Basel)*. 2019;19(8):1749. Published 2019 Apr 12. doi:10.3390/s19081749
10. P. Lathiya and J. Wang, "Influence of Hydraulic Pressure on Dynamic Magnetic Properties of Ni-Cu-Zn Ferrites," in *IEEE Magnetics Letters*, vol. 10, pp. 1-5, 2019, Art no. 7110505.
11. P. Lathiya and J. Wang, "Effects of the Sintering Temperature on RF Complex Permeability of NiCuCoZn Ferrites for Near-Field Communication Applications," in *IEEE Transactions on Magnetics*, vol. 55, no. 2, pp. 1-4, Feb. 2019, Art no. 2800404.
12. D. C. Lugo, R. A. Ramirez, J. Wang and T. M. Weller, "Multilayer Dielectric End-Fire Antenna With Enhanced Gain," in *IEEE Antennas and Wireless Propagation Letters*, vol. 17, no. 12, pp. 2213-2217, Dec. 2018.
13. A. Alsolami, A. Zaman, I. F. Rivera, M. Baghelani and J. Wang, "Improvement of Deep Reactive Ion Etching Process For Motional Resistance Reduction of Capacitively Transduced Vibrating Resonators," in *IEEE Sensors Letters*, vol. 2, no. 1, pp. 1-4, March 2018.
14. O. F. Firat, M. M. Abdin, J. Wang and T. M. Weller, "Low-Loss Suspended Crossover Interconnects using Laser Enhanced Direct Print Additive Manufacturing," *2019 IEEE 20th Wireless and Microwave Technology Conference (WAMICON)*, 2019, pp. 1-4.

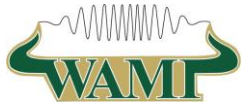

15. V. Kosamiya, J. Wang, "High-k and Low-Loss Dielectric Composite Feedstock Filaments Tailored for Additive Manufacturing of Microwave Devices," *2020 IEEE MTT-S International Microwave Symposium (IMS)*, August, 2020.
16. P. Lathiya, M. Kreuzer, and J. Wang, "RF complex permeability spectra of Ni-Cu-Zn ferrites for wireless power transfer (WPT) under different applied hydraulic pressures and durations," *14th Joint MMM-Intermag Conference*, January 14-18, 2019, Washington DC.
17. M. M. Abdin, W. J. D. Johnson, J. Wang and T. M. Weller, "W-band Finite Ground Coplanar Waveguide (FG-CPW) using Laser Enhanced Direct-Print Additive Manufacturing (LE-DPAM)," *2019 IEEE MTT-S International Microwave Symposium (IMS)*, Boston, MA, 2019, pp. 1213-1216.
18. E. Gonzalez and G. Mumcu, "Mm-Wave Beam-Steering Focal Plane Arrays with Microfluidically Switched Feed Networks," *IEEE Transactions on Antennas and Propagation*, vol. 66, no. 12, pp. 7424 – 7429, Dec. 2018.
19. G. Mumcu, M. Kacar, and J. Mendoza, "Mm-Wave Beam Steering Antenna With Reduced Hardware Complexity Using Lens Antenna Subarrays," *IEEE Antennas and Wireless Propagation Letters*, vol. 17, no. 9, pp. 1603 – 1607, Sept. 2018.
20. A. Qaroot and G. Mumcu, "Microfluidically Reconfigurable Reflection Phase Shifter," *IEEE Microwave and Wireless Components Letters*, vol. 28, no. 8, pp. 684 – 686, Aug. 2018.
21. D. Zaiden, J. Granfield, T. Weller, and G. Mumcu, "Compact and Wideband MMIC Phase Shifters Using Tunable Active Inductor Loaded All-Pass Networks," *IEEE Transactions on Microwave Theory and Techniques*, vol. 66, no. 2, pp. 1047 – 1057, Feb. 2018.
22. T. Palomo and G. Mumcu, "Microfluidically Reconfigurable Microstrip Line Combline Filters with Wide Frequency Tuning Capabilities," *IEEE Transactions on Microwave Theory and Techniques*, vol. 65, no. 10, pp. 3561 – 3568, Oct. 2017.
23. M. Beygi, G. Mumcu and S. E. Sadow, "Neural Implant Materials: Safety Evaluation in Implanted Neural Probes Under MRI," *SoutheastCon 2018, St. Petersburg, FL*, 2018, pp. 1-2.
24. E. Gonzalez and G. Mumcu, "Low-Loss Microfluidically Reconfigurable Multi-Throw RF Switches & Related Mm-Wave Beam-Steering Applications," *presented in 2018 IEEE International Symposium on Antennas and Propagation and USNC-URSI Radio Science Meeting*, Boston, MA, USA, July 2018 (**invited**).
25. J. Mendoza, M. Karabacak, H. Arslan, and G. Mumcu, "A Microfluidically Controlled Spatially Adaptive Antenna Array For Mm-Wave Wireless Channel Control," *presented in 2018 IEEE International Symposium on Antennas and Propagation and USNC-URSI Radio Science Meeting*, Boston, MA, USA, July 2018.
26. G. Mumcu, "Microfluidically Loaded Wideband Frequency Tunable Antennas and RF Filters," *Workshop on Tunable Passive Devices for Multi-band Systems, IEEE International Microwave Symposium (IMS)*, Philadelphia, PA, USA, June 2018 (**invited**).
27. A. Menon, G. Mumcu, and T. M. Weller, "Implementation and enhancement of Hilbert transform-based calibration in a K band FMCW radar for high-resolution security applications," *Proceedings of SPIE 10633, Radar Sensor Technology XXII*, 106330N (4 May 2018).

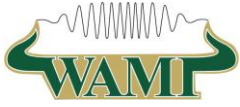

28. A. Menon, A. Snider, G. Mumcu and T. Weller, "An 18–26 GHz range calibrated linear synthetic aperture radar prototype suitable for security applications," *2018 IEEE 19th Wireless and Microwave Technology Conference (WAMICON)*, Sand Key, FL, 2018, pp. 1-4.
29. M. Kacar, T. Weller, G. Mumcu, P. Deffenbaugh, C. Perkowski, and K. Church, "Direct Digital Manufacturing of an X/Ku-Band Conformal Phased Array Antenna", *Government Microcircuit Applications & Critical Technology Conference (GOMACTech) 2018*.
30. E. González and G. Mumcu, "Mm-Wave Beam-Scanning Focal Plane Arrays with Microfluidically Switched Feed Networks," *URSI - National Radio Science Meeting*, Boulder, CO, USA, Jan. 2018.
31. M. Kacar, C. Perkowski, P. Deffenbaugh, K. Church, T. Weller and G. Mumcu, "X-Band Conformal Antenna Fabrication Using Direct Digital Manufacturing," *URSI - National Radio Science Meeting*, Boulder, CO, USA, Jan. 2018 (**invited**).
32. A. W. Khan, T. Wanchoo, G. Mumcu, and S. Kose, "Implications of Distributed On-Chip Power Delivery on EM Side-Channel Attacks," *IEEE International Conference on Computer Design (ICCD)*, pp. 329 – 336, 5 – 8 Nov. 2017.
33. M. Kacar, C. Perkowski, P. Deffenbaugh, J. Booth, G. Mumcu, and T. Weller "Wideband Ku-Band Antennas using Multi-Layer Direct Digital Manufacturing," *IEEE Antennas and Propagation Society Symposium*, pp. 1 – 2, San Diego, CA, July 9 – July 14, 2017.
34. E. Gonzalez and G. Mumcu, "Mm-Wave 2D Beam-Steering Focal Plane Array with Microfluidically Switched Feed Network," *IEEE Antennas and Propagation Society Symposium*, pp. 1 – 2, San Diego, CA, July 9 – July 14, 2017.
35. A. Alsolami, A. Zaman, I. F. Rivera, M. Baghelani and J. Wang, "Improvement of Deep Reactive Ion Etching Process For Motional Resistance Reduction of Capacitively Transduced Vibrating Resonators," in *IEEE Sensors Letters*, vol. 2, no. 1, pp. 1-4, March 2018.
36. D. C. Lugo, R. A. Ramirez, J. Wang and T. M. Weller, "Multilayer Dielectric End-Fire Antenna With Enhanced Gain," in *IEEE Antennas and Wireless Propagation Letters*, vol. 17, no. 12, pp. 2213-2217, Dec. 2018.
37. U. M. Carthy, I. Uysal, R. Badia-Melis, S. Mercier, C. O'Donnell, and A. Ktenioudaki, "Global food security issues, challenges and technological solutions," *Trends in Food Science & Technology*, vol. 77, pp. 11 – 20, 2018.
38. S. Mercier and I. Uysal, "Noisy matrix completion on a novel neural network framework," *Chemometrics and Intelligent Laboratory Systems*, vol. 177, pp. 1–7, 2018
39. O. Kilinc and I. Uysal, "Gar: an efficient and scalable graph-based activity regularization for semisupervised learning," *Neurocomputing*, vol. 296, pp. 46–54, 2018
40. S. Mercier and I. Uysal, "Neural network models for predicting perishable food temperatures along the supply chain," *Biosystems Engineering*, vol. 171, pp. 91–100, 2018
41. O. Kilinc and I. Uysal, "Learning latent representations in neural networks for clustering through pseudo supervision and graph-based activity regularization," in *Learning Representation (ICLR), International Conference on*, pp. OpenReview.net/PDF ID:HkMvEOIAb (1–16), 2018.

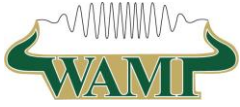

42. M. Aktukmak, S. Mercier, and I. Uysal, "A neural net framework for accumulative featurebased matrix completion," in *Neural Networks (IJCNN), 2018 International Joint Conference on*, pp. 1750–1755, IEEE, 2018.
43. N. G. Jeevarathnam and I. Uysal, "Grid-based rfid localization using tag read count and received signal strength," in *Neural Networks (IJCNN), 2018 International Joint Conference on*, pp. 5238–5245, IEEE, 2018. R. Hajji, Kim Tran, L. Dunleavy and L. Levesque, "Rapid Model-Based Evaluation Board Success for a 160W L-Band GaN PA," MPD Digest, Feb. 2018.
44. Kevin Kellogg, Sourabh Khandelwal, Neil Craig and Larry Dunleavy, "Improved Charge Modeling of Field-plate Enhanced AlGaIn/GaN HEMT Devices Using a Physics Based Compact Model," *Accepted for presentation at 2018 IEEE BiCMOS and Compound Semiconductor Integrated Circuits and Technology Symposium (BCICTS)*.
45. K. Kellogg, L. Dunleavy and A.D. Snider, "Temperature Dependent Noise System Verification and the Relationship of Passive Noise Parameters to Available Gain Calculations," *IEEE WAMICON 2018*, April 2018, Clearwater, FL.
46. K. Kellogg, S. Khandelwal, L. Dunleavy and J. Wang, "Characterization of Thermal and Trapping Time Constants in a GaN HEMT," *2020 94th ARFTG Microwave Measurement Symposium (ARFTG)*, 2020, pp. 1-4.
47. M. Wen, J. Li, S. Dang, Q. Li, S. Mumtaz, H. Arslan, "Joint-Mapping Orthogonal Frequency Division Multiplexing with Subcarrier Number Modulation," *IEEE Transactions on Communications*, 69(7), 4306-4318, July. 2021.
48. M. M. Sahin, I. E. Gurol, E. Arslan, E. Basar, H. Arslan, "OFDM-IM for Joint Communication and Radar-Sensing: A Promising Waveform for Dual Functionality," *Frontiers in Communications and Networks*, vol.2, p.34, 2021.
49. M. Karabacak, B. Pekoz, G. Mumcu, H. Arslan, "Arraymetrics: Authentication Through Chaotic~Antenna Array Geometries," *IEEE Communications Letters*, 25(6), 1801-1804, June 2021.
50. A. Abushattal, S. Althunibat, M. Qaraqe, H. Arslan, "A Secure Downlink NOMA scheme Against Unknown Internal Eavesdroppers," *IEEE Wireless Communications Letters*, 10(6), 1281-1285, June 2021.
51. E. Memisoglu, A. E. Duranay, H. Arslan, "Numerology Scheduling for PAPR Reduction in Mixed Numerologies," *IEEE Wireless Communications Letters*, 10(1), 1197-1201, June 2021.
52. M. S. J. Solaija, H. Salman, A. B. Kihero, M. I. Saglam, H. Arslan, "Generalized Coordinated Multipoint Framework for 5G and Beyond," *IEEE Access*, 9(1), 72499-72515, May. 2021.
53. S. Dogan-Tusha, A. Tusha, E. Basar, S. Althunibat, K. Qaraqe, H. Arslan, "Inter-numerology Interference in OFDM-IM Systems," *IET Communications*, 1-9, May. 2021.
54. J. F. Valgas, J. F. Monserrat, H. Arslan, "Flexible Numerology in 5G NR: Interference Quantification and Proper Selection Depending on the Scenario," *Hindawi Mobile Information Systems*, vol. 2021, 9 pages, Mar. 2021 .

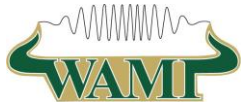

55. S. Dogan-Tusha, A. Tusha, E. Basar, H. Arslan, "Multidimensional Index Modulation for 5G and Beyond Wireless Networks," *Proceedings of the IEEE*, 109(2), 170-199, Feb. 2021.
56. H. M. Furqan, M. S. J. Solaija, H. Turkmen, H. Arslan, "Wireless Communication, Sensing, and REM: A Security Perspective," *IEEE Open Journal of the Communications Society*, 2(1), 287-321, Jan. 2021.
57. H. Turkmen, M. S. J. Solaija, A. Tusha, H. Arslan, "Wireless Sensing - Enabler of Future Wireless Technologies," *Turkish Journal of Electrical Engineering & Computer Sciences*, 29(1), 1-17, Jan. 2021.
58. M. M. Sahin, H. Arslan, "Application-Based Coexistence of Different Waveforms on Non-Orthogonal Multiple Access," *IEEE Open Journal of the Communications Society*, 2(1), 67-79, Jan. 2021.
59. S. E. Zegrar, A. E. Duranay, H. Arslan, "Precoding Based Cross-Tier Interference Mitigation in Centralized-RAN," *IEEE Wireless Communications Letters*, 10(1), 21-25, Jan. 2021.
60. H. M. Furqan, J. M. Hamamreh, H. Arslan, "New Physical Layer Key Generation Dimensions: Subcarrier Indices/Positions-Based Key Generation," *IEEE Communications Letters*, 25(1), 59-63, Jan. 2021.
61. M. A. Aygul, M. Nazzal, M. I. Saglam, D. B. da Costa, H. F. Ates, H. Arslan, "Efficient Spectrum Occupancy Prediction Exploiting Multidimensional Correlations through Composite 2D-LSTM Models," *Sensors*, 21(1), 2021.
62. A. Yazar, S. Dogan-Tusha, H. Arslan, "6G Vision: An Ultra-Flexible Perspective," *ITU Journal on Future and Evolving Technologies*, 1(9), 1-20, Dec. 2020.
63. M. B. Janjua, A. E. Duranay, H. Arslan, "Role of Wireless Communication in Healthcare System to Cater Disaster Situations under 6G Vision," *Frontiers in Communications and Networks, section Wireless Communications*, 1(610879), Dec. 2020.
64. M. Karabacak, H. Arslan, G. Mumcu, "Lens Antenna Subarrays in mmWave Hybrid MIMO Systems," *IEEE Access*, 8(1), 216634-216644, Dec. 2020.
65. M. Karabacak, L. Afeef, H. Arslan, "Dynamic Sidelobe Multiplexing in Beamspace MIMO Systems," *IEEE Wireless Communications Letters*, 9(12), 2216-2219, Dec. 2020.
66. C. Seker, M. T. Guner, H. Arslan, "Millimeter-Wave Propagation Modelling and Characterization at 32 GHz in Indoor Office for 5G Networks," *International Journal of RF and Microwave Computer-Aided Engineering*, 30(12), 1-12, Dec. 2020.
67. J. Mendoza, M. Karabacak, H. Arslan, G. Mumcu, "A Spatially Adaptive Antenna Array for Mm-Wave Wireless Channel Control with Microfluidics Based Reconfiguration," *IEEE Access*, 8(1), 182898 - 182907, Oct. 2020.
68. A. Almohamad, A. M. Tahir, A. Al-Kababji, H. M. Furqan, T. Khattab, M. O. Hasna, H. Arslan, "Smart and Secure Wireless Communications via Reflecting Intelligent Surfaces: A Short Survey," *IEEE Open Journal of the Communications Society*, 1(1), 1442-1456, Oct. 2020.
69. Y. Yengi, A. Kavak, H. Arslan, "Physical Layer Detection of Malicious Relays in LTE-A Network Using Unsupervised Learning," *IEEE Access*, 8(1), 154713-154726, Sep. 2020.

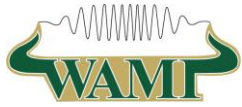

70. A. Naeem, H. Arslan “Joint Radar and Communication based Blind Signal Separation using a New Non-Linear Function for Fast-ICA,” *IEEE Vehicular Technology Conference (VTC-Fall)*, Sep. 27-30, 2021.
71. A. Tusha, S. Dogan-Tusha, F. Yilmaz, S. Althunibat, K. Qaraqey, H. Arslan ” Physical Effect of In-Phase and Quadrature Imbalance in Delay-Doppler Domain,” *IEEE Vehicular Technology Conference (VTC-Fall)*, Sep. 27-30, 2021.
72. M. Nazzal, M. A. Aygul, H. Arslan ” Sparse Coding with Enhanced Atom Selection for FDD Massive MIMO Channel Estimation,” *IEEE Vehicular Technology Conference (VTC-Fall)*, Sep. 27-30, 2021.
73. S. Abidrabbu, H. Arslan ” Efficient Power Allocation for MIMO CR-NOMA Networks,” *IEEE Vehicular Technology Conference (VTC-Fall)*, Sep. 27-30, 2021.
74. S. M. T. Shah, M. A. Hamood, H. Arslan “Efficient Spectral Access in Distributed Cooperative Cognitive Radio Networks” *IEEE Vehicular Technology Conference (VTC-Fall)*, Sep. 27-30, 2021.
75. S. Rafique, H. Arslan “A Novel Frame Design for Integrated Communication and Sensing based on Position Modulation,” *IEEE Vehicular Technology Conference (VTC-Fall)*, Sep. 27-30, 2021.
76. S. E. Zegrar, L. Afeef , H. Arslan, “Reconfigurable Intelligent Surface (RIS): Eigenvalue Decomposition-Based Separate Channel Estimation,” *IEEE International Symposium on Personal, Indoor, and Mobile Radio Communications (PIMRC)*, Sep. 13-16, 2021.
77. M. A. Aygul, M. Nazzal, H. Arslan, “Using OMP and SD Algorithms Together in Millimeter Wave Massive MIMO Channel Estimation,” *IEEE Signal Processing and Communications Applications Conference (SIU)*, June 9-11, 2021.
78. A. Jaradat, K. Elgammal, M. K. Ozdemir, H. Arslan “ Identification of the number of Wireless Channel Taps Using Deep Neural Networks,” *IEEE Interregional NEWCAS Conference* , June 13-16, 2021.
79. S. Abidrabbu, H. Arslan, “ Efficient Power Allocation for Cognitive Radio NOMA using Game-Theoretic Based Pricing Strategy,” *IEEE Vehicular Technology Conference (VTC-Spring)*, Apr. 25-28, 2021.
80. A. Jaradat, J. M. Hamamreh, H. Arslan, “Floating OFDM-SNM for PAPR and OOB Reduction,” *IEEE Vehicular Technology Conference (VTC-Spring)*, Apr. 25-28, 2021.
81. F. Ahmed, H. Arslan, “Signal Statistics based Multiple AP Detection for Smart Spectrum Sharing in LTE-U/Wi-Fi Coexistence,” *IEEE Vehicular Technology Conference (VTC-Spring)*, Apr. 25-28, 2021
82. S. Abidrabbu, H. Arslan, “Energy-Efficient Resource Allocation for 5G Cognitive Radio NOMA Using Game Theory,” *IEEE Wireless Communications and Networking Conference (WCNC)*, Mar. 29 – Apr. 1, 2021.
83. A. Abushattal, H. Arslan, “Phase Index-Based Receive Spatial Modulation PHY Security Against Supervised Pattern Recognition,” *IEEE Wireless Communications and Networking Conference (WCNC)*, Mar. 29 – Apr. 1, 2021.

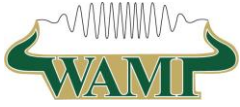

84. H. Salman, M. B. Janjua, H. Arslan, “ Improving Connectivity via Multi-User Scheduling in 5G and Beyond Networks,” *IEEE Wireless Communications and Networking Conference (WCNC)*, Mar. 29 – Apr. 1, 2021.
85. M. A. Aygul, M. Nazzal, H. Arslan, “ Deep Learning-Based Optimal RIS Interaction Exploiting Previously Sampled Channel Correlations,” *IEEE Wireless Communications and Networking Conference (WCNC)*, Mar. 29 – Apr. 1, 2021.
86. A. Jaradat, E. Memisoglu, H. Arslan, “ Blind Numerology Identification for Mixed Numerologies,” *IEEE Wireless Communications and Networking Conference (WCNC)*, Mar. 29 – Apr. 1, 2021.
87. M. M. Sahin, H. Arslan, “ Multi-functional Coexistence of Radar-Sensing and Communication Waveforms,” *IEEE Vehicular Technology Conference (VTC-Fall)*, Nov. 18 – Dec. 16, 2020.
88. M. A. Aygul, H. M. Furqan, M. Nazzal, H. Arslan, “ Deep Learning Assisted Detection of PUEA and Jamming Attack in Cognitive Radio Systems,” *IEEE Vehicular Technology Conference (VTC-Fall)*, Nov. 18 – Dec. 16, 2020.
89. A. Abushattal, S. Althunibat, M. Qaraqe, H. Arslan, “On the Inherent Physical-Layer Security of Receive Spatial Modulation Systems,” *IEEE International Workshop on Computer Aided Modeling and Design of Communication Links and Networks (CAMAD)*, Sep. 14-16, 2020.
90. H. M. Furqan, J. M. Hamamreh, H. Arslan, “Secure and Reliable IoT Communications Using Nonorthogonal Signals’ Superposition with Dual-Transmission,” *IEEE International Symposium on Personal, Indoor, and Mobile Radio Communications (PIMRC)*, Aug. 31 – Sep. 3, 2020.
91. A. Jaradat, J. M. Hamamreh, H. Arslan, “Orthogonal Frequency Division Multiplexing with Subcarrier Gap Modulation,” *IEEE International Symposium on Personal, Indoor, and Mobile Radio Communications (PIMRC)*, Aug. 31 – Sep. 3, 2020.